

Alustyle

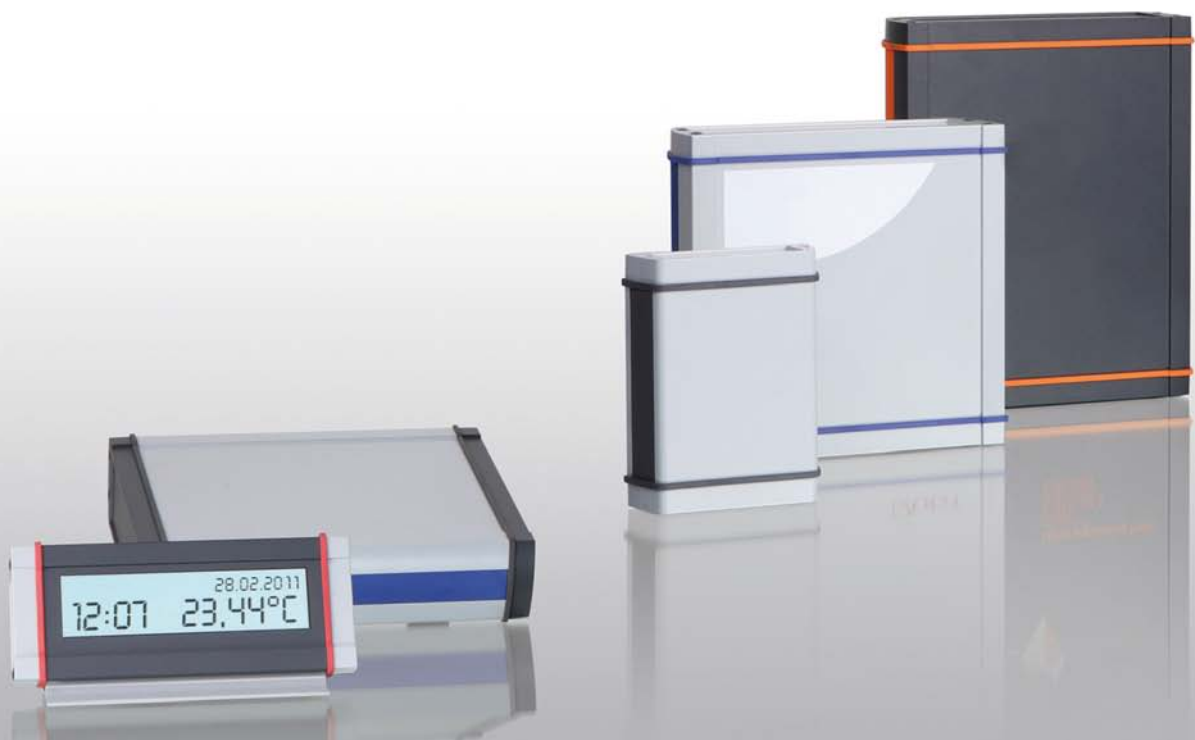

Detailed product information can be found on www.bopla.de



- 3 profile variants
- 4 profile cross-sections
- Standard lengths ex warehouse
- Special lengths available at short notice
- Functional diecast zinc end covers
- Ingress protection up to IP 67
- Good EMC shielding
- Powder-coating, depending on type, similar to RAL 7024 or 9006
- Design seals in 5 colours
- Special colours on request
- Wide range of accessories

Colour:

Graphite grey, similar to RAL 7024 or silver, similar to RAL 9006; dark grey seal; special colours on request

Protection class:

ASP: up to IP 66 / IP 67/DIN EN 60529 when used with ASD; ASPH: IP 65/DIN EN 60529; ASPU: IP 40/DIN EN 60529

Enclosure material:

Extruded profiles: Al Mg Si 0.5 powder-coated; diecast lid: zinc alloy Z410, powder-coated; seal: TPE; for details see Technical Information

Constructive refinement, functional accessories and elegant design are certain to impress you

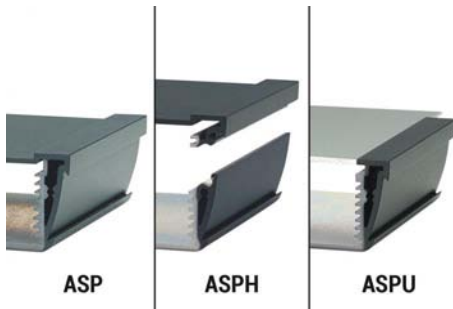

Variable lengths and the profile variants closed (ASP), horizontally divided (ASPH) or open on one side (ASPU) ensure versatile uses.



Recessed profile side for mounting membrane keypads up to 2 mm; smooth profile side for printing, laser engraving etc.



The PCB plug-in slots have identical dimensions on all levels up to immediately under the lid area.



Contact surfaces which contact the lid to the profile guarantee good EMC protection. EMC seals are available if greater protection is required.



ASD – end cover with a 2 mm recessed area for fitting keypads or technical components.

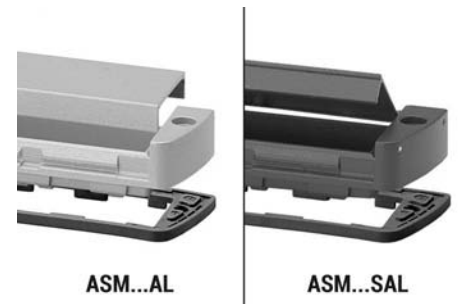

Removable or hinged lids with a high level of protection are available when battery compartments or service interfaces are required.



The enclosure can be used on edge or inclined by means of a tower or tip-up foot inserted from the side.

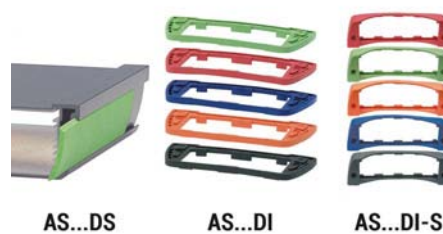

Different design elements provide individual colour options and mechanical protection for the enclosure.

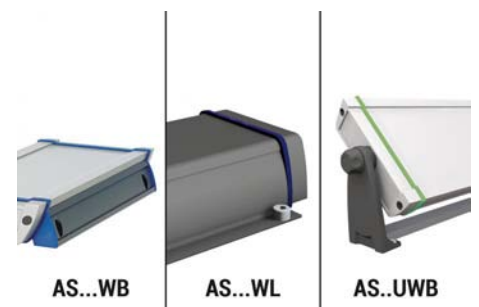

For wall mounting: wall fitting (AS...WB), wall bracket (AS...WL), universal wall fitting (AS...UWB)

Alustyle 830 | Enclosure profiles

Enclosure profiles, closed



Model	Order no.	A	B	C	Colour
ASP 830-0100	94112100	74	32,8	100	Graphite grey
ASP 830-0100	94111100	74	32,8	100	Silver
ASP 830-0150	94112150	74	32,8	150	Graphite grey
ASP 830-0150	94111150	74	32,8	150	Silver
ASP 830-0200	94112200	74	32,8	200	Graphite grey
ASP 830-0200	94111200	74	32,8	200	Silver
ASP 830-1000	94112000	74	32,8	1000	Graphite grey
ASP 830-1000	94111000	74	32,8	1000	Silver

Scope of delivery: Enclosure profile

Note: C = profile length, special lengths on request.



Enclosure profiles, horizontally-divided

Model	Order no.	A	B	C	Colour
ASPH 830-0100	94212100	74	32,8	100	Graphite grey
ASPH 830-0100	94211100	74	32,8	100	Silver
ASPH 830-0150	94212150	74	32,8	150	Graphite grey
ASPH 830-0150	94211150	74	32,8	150	Silver
ASPH 830-0200	94212200	74	32,8	200	Graphite grey
ASPH 830-0200	94211200	74	32,8	200	Silver
ASPH 830-1000	94212000	74	32,8	1000	Graphite grey
ASPH 830-1000	94211000	74	32,8	1000	Silver

Scope of delivery: Enclosure profile, two parts including profile seal

Note: C = profile length, special lengths on request.



Enclosure profiles, open on one side

Model	Order no.	A	B	C	Colour
ASPU 830-0100	94312100	74	32,8	100	Graphite grey
ASPU 830-0100	94311100	74	32,8	100	Silver
ASPU 830-0150	94312150	74	32,8	150	Graphite grey
ASPU 830-0150	94311150	74	32,8	150	Silver
ASPU 830-0200	94312200	74	32,8	200	Graphite grey
ASPU 830-0200	94311200	74	32,8	200	Silver
ASPU 830-1000	94312000	74	32,8	1000	Graphite grey
ASPU 830-1000	94311000	74	32,8	1000	Silver

Scope of delivery: Enclosure profile

Note: C = profile length, special lengths on request.

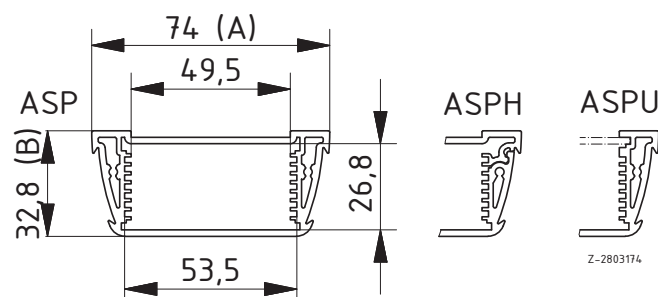

* = Available on request

Alustyle 1030 | Enclosure profiles

Enclosure profiles, closed

Model	Order no.	A	B	C	Colour
ASP 1030-0100	94122100	98,5	32,8	100	Graphite grey
ASP 1030-0100	94121100	98,5	32,8	100	Silver
ASP 1030-0150	94122150	98,5	32,8	150	Graphite grey
ASP 1030-0150	94121150	98,5	32,8	150	Silver
ASP 1030-0200	94122200	98,5	32,8	200	Graphite grey
ASP 1030-0200	94121200	98,5	32,8	200	Silver
ASP 1030-1000	94122000	98,5	32,8	1000	Graphite grey
ASP 1030-1000	94121000	98,5	32,8	1000	Silver

Scope of delivery: Enclosure profile

Note: C = profile length, special lengths on request.



Enclosure profiles, horizontally-divided

Model	Order no.	A	B	C	Colour
ASPH 1030-0100	94222100	98,5	32,8	100	Graphite grey
ASPH 1030-0100	94221100	98,5	32,8	100	Silver
ASPH 1030-0150	94222150	98,5	32,8	150	Graphite grey
ASPH 1030-0150	94221150	98,5	32,8	150	Silver
ASPH 1030-0200	94222200	98,5	32,8	200	Graphite grey
ASPH 1030-0200	94221200	98,5	32,8	200	Silver
ASPH 1030-1000	94222000	98,5	32,8	1000	Graphite grey
ASPH 1030-1000	94221000	98,5	32,8	1000	Silver

Scope of delivery: Enclosure profile, two parts including profile seal

Note: C = profile length, special lengths on request.



Enclosure profiles, open on one side

Model	Order no.	A	B	C	Colour
ASPU 1030-0100	94322100	98,5	32,8	100	Graphite grey
ASPU 1030-0100	94321100	98,5	32,8	100	Silver
ASPU 1030-0150	94322150	98,5	32,8	150	Graphite grey
ASPU 1030-0150	94321150	98,5	32,8	150	Silver
ASPU 1030-0200	94322200	98,5	32,8	200	Graphite grey
ASPU 1030-0200	94321200	98,5	32,8	200	Silver
ASPU 1030-1000	94322000	98,5	32,8	1000	Graphite grey
ASPU 1030-1000	94321000	98,5	32,8	1000	Silver

Scope of delivery: Enclosure profile

Note: C = profile length, special lengths on request.

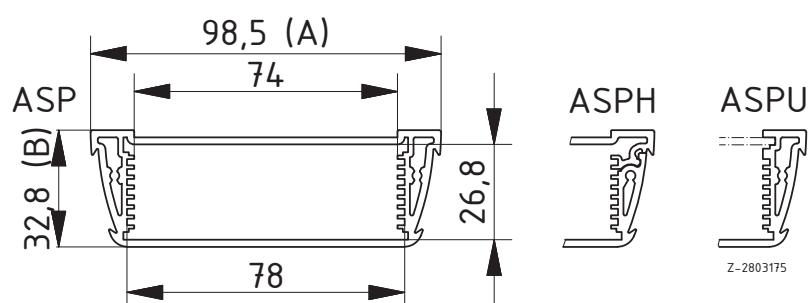

For accessories, please see the end of the chapter

Alustyle 1230 | Enclosure profiles



Enclosure profiles, closed

Model	Order no.	A	B	C	Colour
ASP 1230-0100	94132100	121	32,8	100	Graphite grey
ASP 1230-0100	94131100	121	32,8	100	Silver
ASP 1230-0150	94132150	121	32,8	150	Graphite grey
ASP 1230-0150	94131150	121	32,8	150	Silver
ASP 1230-0200	94132200	121	32,8	200	Graphite grey
ASP 1230-0200	94131200	121	32,8	200	Silver
ASP 1230-1000	94132000	121	32,8	1000	Graphite grey
ASP 1230-1000	94131000	121	32,8	1000	Silver

Scope of delivery: Enclosure profile

Note: C = profile length, special lengths on request.



Enclosure profiles, horizontally-divided

Model	Order no.	A	B	C	Colour
ASPH 1230-0100	94232100	121	32,8	100	Graphite grey
ASPH 1230-0100	94231100	121	32,8	100	Silver
ASPH 1230-0150	94232150	121	32,8	150	Graphite grey
ASPH 1230-0150	94231150	121	32,8	150	Silver
ASPH 1230-0200	94232200	121	32,8	200	Graphite grey
ASPH 1230-0200	94231200	121	32,8	200	Silver
ASPH 1230-1000	94232000	121	32,8	1000	Graphite grey
ASPH 1230-1000	94231000	121	32,8	1000	Silver

Scope of delivery: Enclosure profile, two parts including profile seal

Note: C = profile length, special lengths on request.

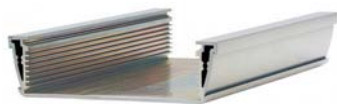

Enclosure profiles, open on one side

Model	Order no.	A	B	C	Colour
ASPU 1230-0100	94332100	121	32,8	100	Graphite grey
ASPU 1230-0100	94331100	121	32,8	100	Silver
ASPU 1230-0150	94332150	121	32,8	150	Graphite grey
ASPU 1230-0150	94331150	121	32,8	150	Silver
ASPU 1230-0200	94332200	121	32,8	200	Graphite grey
ASPU 1230-0200	94331200	121	32,8	200	Silver
ASPU 1230-1000	94332000	121	32,8	1000	Graphite grey
ASPU 1230-1000	94331000	121	32,8	1000	Silver

Scope of delivery: Enclosure profile

Note: C = profile length, special lengths on request.

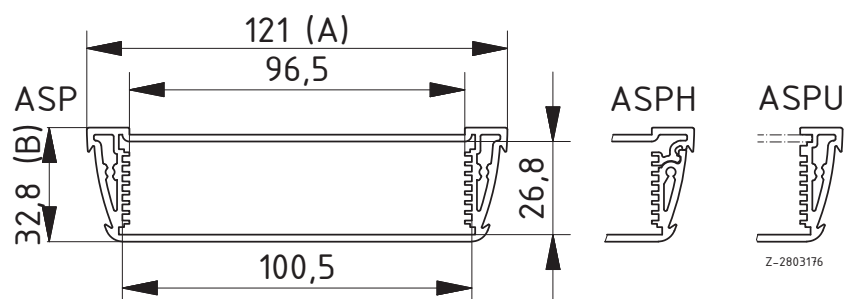

Z-2803176

* = Available on request

Alustyle 1850 | Enclosure profiles

Enclosure profiles, closed

Model	Order no.	A	B	C	Colour
ASP 1850-0100	94142100	187	54,6	100	Graphite grey
ASP 1850-0100	94141100	187	54,6	100	Silver
ASP 1850-0150	94142150	187	54,6	150	Graphite grey
ASP 1850-0150	94141150	187	54,6	150	Silver
ASP 1850-0200	94142200	187	54,6	200	Graphite grey
ASP 1850-0200	94141200	187	54,6	200	Silver
ASP 1850-1000	94142000	187	54,6	1000	Graphite grey
ASP 1850-1000	94141000	187	54,6	1000	Silver

Scope of delivery: Enclosure profile

Note: C = profile length, special lengths on request.

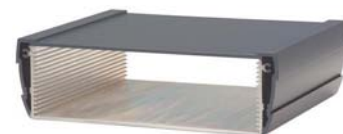

Enclosure profiles, horizontally-divided

Model	Order no.	A	B	C	Colour
ASPH 1850-0100	94242100	187	54,6	100	Graphite grey
ASPH 1850-0100	94241100	187	54,6	100	Silver
ASPH 1850-0150	94242150	187	54,6	150	Graphite grey
ASPH 1850-0150	94241150	187	54,6	150	Silver
ASPH 1850-0200	94242200	187	54,6	200	Graphite grey
ASPH 1850-0200	94241200	187	54,6	200	Silver
ASPH 1850-1000	94242000	187	54,6	1000	Graphite grey
ASPH 1850-1000	94241000	187	54,6	1000	Silver

Scope of delivery: Enclosure profile, two parts including profile seal

Note: C = profile length, special lengths on request.



Enclosure profiles, open on one side

Model	Order no.	A	B	C	Colour
ASPU 1850-0100	94342100	187	54,6	100	Graphite grey
ASPU 1850-0100	94341100	187	54,6	100	Silver
ASPU 1850-0150	94342150	187	54,6	150	Graphite grey
ASPU 1850-0150	94341150	187	54,6	150	Silver
ASPU 1850-0200	94342200	187	54,6	200	Graphite grey
ASPU 1850-0200	94341200	187	54,6	200	Silver
ASPU 1850-1000	94342000	187	54,6	1000	Graphite grey
ASPU 1850-1000	94341000	187	54,6	1000	Silver

Scope of delivery: Enclosure profile

Note: C = profile length, special lengths on request.

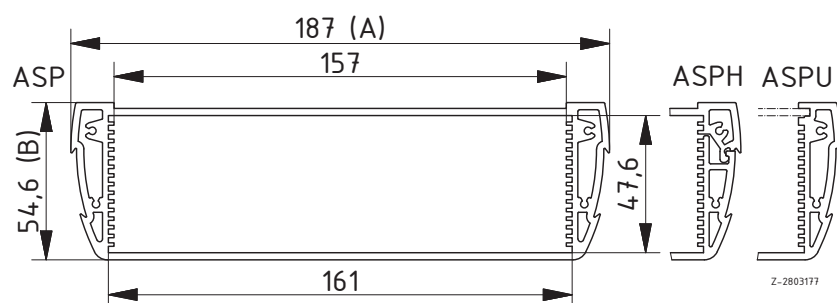

For accessories, please see the end of the chapter

Alustyle | Accessories



End cover

Model	Order no.	Colour	Note
ASD 830-7024	94412100	Graphite grey	For ASP... 830
ASD 830-9006	94411100	Silver	For ASP... 830
ASD 1030-7024	94422100	Graphite grey	For ASP... 1030
ASD 1030-9006	94421100	Silver	For ASP... 1030
ASD 1230-7024	94432100	Graphite grey	For ASP... 1230
ASD 1230-9006	94431100	Silver	For ASP... 1230
ASD 1850-7024	94442100	Graphite grey	For ASP... 1850
ASD 1850-9006	94441100	Silver	For ASP... 1850

Scope of delivery: Lid including dark grey seal, screws, graphite grey screw covers

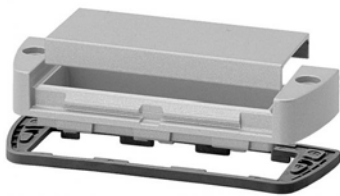

Mounting lid with removable aluminium cap

Model	Order no.	Colour	Note
ASM 830 AL-7024	94412400	Graphite grey	For ASP... 830
ASM 830 AL-9006	94411400	Silver	For ASP... 830
ASM 1030 AL-7024	94422400	Graphite grey	For ASP... 1030
ASM 1030 AL-9006	94421400	Silver	For ASP... 1030
ASM 1230 AL-7024	94432400	Graphite grey	For ASP... 1230
ASM 1230 AL-9006	94431400	Silver	For ASP... 1230

Scope of delivery: Lid including dark grey seal, screws, aluminium cap, cap seal, screws, graphite grey screw covers



Mounting lid with hinged aluminium flap; hinged side = membrane side

Model	Order no.	Colour	Note
ASM 830 SAL1-7024	94412200	Graphite grey	For ASP... 830
ASM 830 SAL1-9006	94411200	Silver	For ASP... 830
ASM 1030 SAL1-7024	94422200	Graphite grey	For ASP... 1030
ASM 1030 SAL1-9006	94421200	Silver	For ASP... 1030
ASM 1230 SAL1-7024	94432200	Graphite grey	For ASP... 1230
ASM 1230 SAL1-9006	94431200	Silver	For ASP... 1230

Scope of delivery: Lid including dark grey seal and aluminium flap, flap seal, screws, graphite grey screw covers

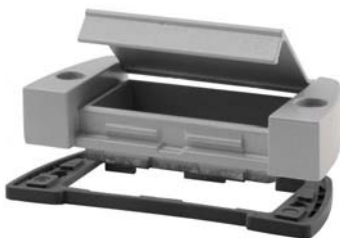

Mounting lid with hinged aluminium flap; hinged side = smooth side

Model	Order no.	Colour	Note
ASM 830 SAL2-7024	94412300	Graphite grey	For ASP... 830
ASM 830 SAL2-9006	94411300	Silver	For ASP... 830
ASM 1030 SAL2-7024	94422300	Graphite grey	For ASP... 1030
ASM 1030 SAL2-9006	94421300	Silver	For ASP... 1030
ASM 1230 SAL2-7024	94432300	Graphite grey	For ASP... 1230
ASM 1230 SAL2-9006	94431300	Silver	For ASP... 1230

Scope of delivery: Lid including dark grey seal and aluminium flap, flap seal, screws, graphite grey screw covers

Alustyle | Accessories

Seals, green

Model	Order no.	Note
AS 830 DI	94513000	For ASD/ASM 830...
AS 1030 DI	94523000	For ASD/ASM 1030...
AS 1230 DI	94533000	For ASD/ASM 1230...
AS 1850 DI	94543000	For ASD/ASM 1850...

Scope of delivery: 10 seals



Seals, red

Model	Order no.	Note
AS 830 DI	94515000	For ASD/ASM 830...
AS 1030 DI	94525000	For ASD/ASM 1030...
AS 1230 DI	94535000	For ASD/ASM 1230...
AS 1850 DI	94545000	For ASD/ASM 1850...

Scope of delivery: 10 seals



Seals, blue

Model	Order no.	Note
AS 830 DI	94514000	For ASD/ASM 830...
AS 1030 DI	94524000	For ASD/ASM 1030...
AS 1230 DI	94534000	For ASD/ASM 1230...
AS 1850 DI	94544000	For ASD/ASM 1850...

Scope of delivery: 10 seals



Seals, orange

Model	Order no.	Note
AS 830 DI	94516000	For ASD/ASM 830...
AS 1030 DI	94526000	For ASD/ASM 1030...
AS 1230 DI	94536000	For ASD/ASM 1230...
AS 1850 DI	94546000	For ASD/ASM 1850...

Scope of delivery: 10 seals



EMC seal, black

Model	Order no.	Note
AS 830 DI-EMV	94518100	For ASD/ASM 830...
AS 1030 DI-EMV	94528100	For ASD/ASM 1030...
AS 1230 DI-EMV	94538100	For ASD/ASM 1230...
AS 1850 DI-EMV	94548100	For ASD/ASM 1850...

Scope of delivery: 10 seals



Alustyle | Accessories



Impact protection seals, green

Model	Order no.	Note
AS 830 DI-S	94513200	For ASD 830-...
AS 1030 DI-S	94523200	For ASD 1030-...
AS 1230 DI-S	94533200	For ASD 1230-...

Scope of delivery: 1 impact protection seal, graphite grey screw covers

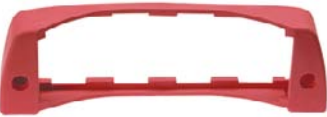

Impact protection seals, red

Model	Order no.	Note
AS 830 DI-S	94515200	For ASD 830-...
AS 1030 DI-S	94525200	For ASD 1030-...
AS 1230 DI-S	94535200	For ASD 1230-...

Scope of delivery: 1 impact protection seal, graphite grey screw covers



Impact protection seals, blue

Model	Order no.	Note
AS 830 DI-S	94514200	For ASD 830-...
AS 1030 DI-S	94524200	For ASD 1030-...
AS 1230 DI-S	94534200	For ASD 1230-...

Scope of delivery: 1 impact protection seal, graphite grey screw covers



Impact protection seals, orange

Model	Order no.	Note
AS 830 DI-S	94516200	For ASD 830-...
AS 1030 DI-S	94526200	For ASD 1030-...
AS 1230 DI-S	94536200	For ASD 1230-...

Scope of delivery: 1 impact protection seal, graphite grey screw covers



Impact protection seals, dark grey

Model	Order no.	Note
AS 830 DI-S	94517200	For ASD 830-...
AS 1030 DI-S	94527200	For ASD 1030-...
AS 1230 DI-S	94537200	For ASD 1230-...

Scope of delivery: 1 impact protection seal, graphite grey screw covers

Alustyle | Accessories

Decor strips, TPE

Model	Order no.	Colour	Note
AS 20-0050 DS	94605050	Red	Length 48.4 mm
AS 20-0050 DS	94603050	Green	Length 48.4 mm
AS 20-0050 DS	94606050	Orange	Length 48.4 mm
AS 20-0050 DS	94604050	Blue	Length 48.4 mm
AS 20-0050 DS	94607050	Dark grey	Length 48.4 mm
AS 20-0100 DS	94605100	Red	Length 98.4 mm
AS 20-0100 DS	94603100	Green	Length 98.4 mm
AS 20-0100 DS	94606100	Orange	Length 98.4 mm
AS 20-0100 DS	94604100	Blue	Length 98.4 mm
AS 20-0100 DS	94607100	Dark grey	Length 98.4 mm
AS 20-0150 DS	94605150	Red	Length 148.4 mm
AS 20-0150 DS	94603150	Green	Length 148.4 mm
AS 20-0150 DS	94606150	Orange	Length 148.4 mm
AS 20-0150 DS	94604150	Blue	Length 148.4 mm
AS 20-0150 DS	94607150	Dark grey	Length 148.4 mm
AS 20-0200 DS	94605200	Red	Length 198.4 mm
AS 20-0200 DS	94603200	Green	Length 198.4 mm
AS 20-0200 DS	94606200	Orange	Length 198.4 mm
AS 20-0200 DS	94604200	Blue	Length 198.4 mm
AS 20-0200 DS	94607200	Dark grey	Length 198.4 mm

Scope of delivery: 10 decor strips

Note: Mounting in the side system grooves. Special lengths up to max. 310 mm on request. As an alternative, individually printed membranes can be used.

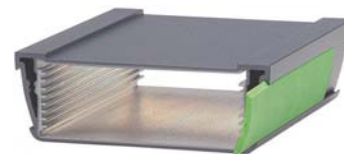

Wall brackets

Model	Order no.	Colour	Note
AS 0030-0100 WB-7024	94772100	Graphite grey	For AS 830/1030/1230, for profile length 100 mm
AS 0030-0100 WB-9006	94771100	Silver	For AS 830/1030/1230, for profile length 100 mm
AS 0030-0150 WB-7024	94772150	Graphite grey	For AS 830/1030/1230, for profile length 150 mm
AS 0030-0150 WB-9006	94771150	Silver	For AS 830/1030/1230, for profile length 150 mm
AS 0030-0200 WB-7024	94772200	Graphite grey	For AS 830/1030/1230, for profile length 200 mm
AS 0030-0200 WB-9006	94771200	Silver	For AS 830/1030/1230, for profile length 200 mm
AS 0050-0100 WB-7024	94742100	Graphite grey	For AS 1850, for profile length 100 mm
AS 0050-0100 WB-9006	94741100	Silver	For AS 1850, for profile length 100 mm
AS 0050-0150 WB-7024	94742150	Graphite grey	For AS 1850, for profile length 150 mm
AS 0050-0150 WB-9006	94741150	Silver	For AS 1850, for profile length 150 mm
AS 0050-0200 WB-7024	94742200	Graphite grey	For AS 1850, for profile length 200 mm
AS 0050-0200 WB-9006	94741200	Silver	For AS 1850, for profile length 200 mm

Scope of delivery: 2 wall fittings (aluminium, powder-coated), 4 covers, graphite grey (TPE)

Note: The wall fittings can be mounted on the closed enclosure at a later date.

Special lengths on request.



Wall brackets

Model	Order no.	Colour	Note
AS 0030-0100 WL-7024	94722100	Graphite grey	For AS 830/1030/1230, for profile length 100 mm
AS 0030-0100 WL-9006	94721100	Silver	For AS 830/1030/1230, for profile length 100 mm
AS 0030-0150 WL-7024	94722150	Graphite grey	For AS 830/1030/1230, for profile length 150 mm
AS 0030-0150 WL-9006	94721150	Silver	For AS 830/1030/1230, for profile length 150 mm
AS 0030-0200 WL-7024	94722200	Graphite grey	For AS 830/1030/1230, for profile length 200 mm
AS 0030-0200 WL-9006	94721200	Silver	For AS 830/1030/1230, for profile length 200 mm

Scope of delivery: 2 wall brackets (aluminium, powder-coated)

Note: Special lengths on request.



Alustyle | Accessories

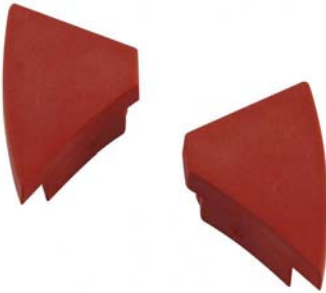

Coloured covers for wall brackets

Model	Order no.	Colour	Note
AS 0030 AK-WB-rot	94785000	Red	For AS 0030-...WB-..., IT 0000.. WB
AS 0030 AK-WB-grün	94783000	Green	For AS 0030-...WB-..., IT 0000.. WB
AS 0030 AK-WB-orange	94786000	Orange	For AS 0030-...WB-..., IT 0000.. WB
AS 0030 AK-WB-blau	94784000	Blue	For AS 0030-...WB-..., IT 0000.. WB
AS 0050 AK-WB-rot	94795000	Red	For AS 0050-...WB-...
AS 0050 AK-WB grün	94793000	Green	For AS 0050-...WB-...
AS 0050 AK-WB-orange	94796000	Orange	For AS 0050-...WB-...
AS 0050 AK-WB-blau	94794000	Blue	For AS 0050-...WB-...

Scope of delivery: 4 covers (TPE)



Universal wall fittings

Model	Order no.	Colour	Note
AS 0100-7024 UWB	94810024	Graphite grey	For profile length 100 mm
AS 0150-7024 UWB	94815024	Graphite grey	For profile length 150 mm
AS 0200-7024 UWB	94820024	Graphite grey	For profile length 200 mm

Scope of delivery: Profile (aluminium), 2 PA6 side flanges (complete), screws, covers

Note: Special lengths on request.



Tower feet

Model	Order no.	Colour	Note
AS 0030-0025 T-7024	94762025	Graphite grey	For AS 830/1030/1230, length 25 mm
AS 0030-0025 T-9006	94761025	Silver	For AS 830/1030/1230, length 25 mm
AS 0030-0100 T-7024	94762100	Graphite grey	For AS 830/1030/1230, for profile length 100 mm
AS 0030-0100 T-9006	94761100	Silver	For AS 830/1030/1230, for profile length 100 mm
AS 0030-0150 T-7024	94762150	Graphite grey	For AS 830/1030/1230, for profile length 150 mm
AS 0030-0150 T-9006	94761150	Silver	For AS 830/1030/1230, for profile length 150 mm
AS 0030-0200 T-7024	94762200	Graphite grey	For AS 830/1030/1230, for profile length 200 mm
AS 0030-0200 T-9006	94761200	Silver	For AS 830/1030/1230, for profile length 200 mm
AS 0050-0025 T-7024	94732025	Graphite grey	For AS 1850, length 25 mm
AS 0050-0025 T-9006	94731025	Silver	For AS 1850, length 25 mm
AS 0050-0100 T-7024	94732100	Graphite grey	For AS 1850, for profile length 100 mm
AS 0050-0100 T-9006	94731100	Silver	For AS 1850, for profile length 100 mm
AS 0050-0150 T-7024	94732150	Graphite grey	For AS 1850, for profile length 150 mm
AS 0050-0150 T-9006	94731150	Silver	For AS 1850, for profile length 150 mm
AS 0050-0200 T-7024	94732200	Graphite grey	For AS 1850, for profile length 200 mm
AS 0050-0200 T-9006	94731200	Silver	For AS 1850, for profile length 200 mm

Scope of delivery: 1 tower foot (aluminium), 4 rubber feet or 2 tower feet (aluminium), 4 rubber feet with AS 0030-0025 T-...

Note: For 25 mm length, decor strips are needed to fill the grooves.

AS 0050-...T-... can also be used as a console tip-up foot for AS 830/1030/1230.

Special lengths on request.

Alustyle | Accessories

Tip-up feet

Model	Order no.	Colour	Note
AS 0030-0025 A-7024	94752025	Graphite grey	Tip-up foot, length 25 mm
AS 0030-0025 A-9006	94751025	Silver	Tip-up foot, length 25 mm
AS 0030-0100 A-7024	94752100	Graphite grey	For profile length 100 mm
AS 0030-0100 A-9006	94751100	Silver	For profile length 100 mm
AS 0030-0150 A-7024	94752150	Graphite grey	For profile length 150 mm
AS 0030-0150 A-9006	94751150	Silver	For profile length 150 mm
AS 0030-0200 A-7024	94752200	Graphite grey	For profile length 200 mm
AS 0030-0200 A-9006	94751200	Silver	For profile length 200 mm

Scope of delivery: 1 tip-up foot (aluminium) or 2 tip-up feet (aluminium) with AS 0030-0025 A-...

Note: For 25 mm length, decor strips are needed to fill the grooves.

Special lengths on request.



Front panels, 2 mm, natural-coloured anodised aluminium

Model	Order no.	Note
ASPU 830-0100 FP2	94310100	For ASPU 830-0100, 2 mm
ASPU 830-0150 FP2	94310150	For ASPU 830-0150, 2 mm
ASPU 830-0200 FP2	94310200	For ASPU 830-0200, 2 mm
ASPU 830-1000 FP2	94310000	For ASPU 830-1000, 2 mm
ASPU 1030-0100 FP2	94320100	For ASPU 1030-0100, 2 mm
ASPU 1030-0150 FP2	94320150	For ASPU 1030-0150, 2 mm
ASPU 1030-0200 FP2	94320200	For ASPU 1030-0200, 2 mm
ASPU 1030-1000 FP2	94320000	For ASPU 1030-1000, 2 mm
ASPU 1230-0100 FP2	94330100	For ASPU 1230-0100, 2 mm
ASPU 1230-0150 FP2	94330150	For ASPU 1230-0150, 2 mm
ASPU 1230-0200 FP2	94330200	For ASPU 1230-0200, 2 mm
ASPU 1230-1000 FP2	94330000	For ASPU 1230-1000, 2 mm
ASPU 1850-0100 FP2,5	94340100	For ASPU 1850-0100, 2,5 mm
ASPU 1850-0150 FP2,5	94340150	For ASPU 1850-0150, 2,5 mm
ASPU 1850-0200 FP2,5	94340200	For ASPU 1850-0200, 2,5 mm
ASPU 1850-1000 FP2,5	94340000	For ASPU 1850-1000, 2,5 mm

Scope of delivery: 1 front panel



Battery compartments

Model	Order no.	Note
AS-BE-3MN	94833000	For ASM 1030/1230, For 3 x mignon (LR6, R06, AM3, E91, AA)
AS-BE-4MN	94834000	For ASM 1030/1230, For 4 mignon batteries (LR6, R06, AM3, E91, AA)
AS-BE-9V	94839000	For ASM 830/1030/1230, For 9 V block (6LR61, 6AM6, 522)

Scope of delivery: 5 battery compartments

Note: Processing of the ASM mounting lid is required if battery compartments are to be fitted.



Design lid for profile size 1230

Model	Order no.	Colour
ASD 1230 D-9006	94431600*	Silver
ASD 1230 D-7024	94432600*	Graphite grey

Scope of delivery: Lid including dark grey seal, screws, graphite grey screw covers

